

**BLUE  
SKY  
REPS**

Electrical Division of Rainier Marketing

# Product Update

Servicing: WA • OR • ID • MT

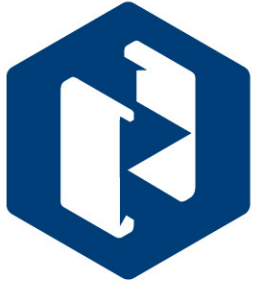

# HAYDON®

*Get Strut Done.*

**Save Time, Earn More!**

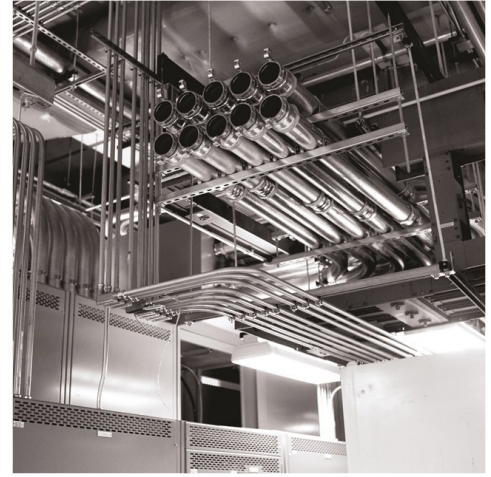

## Haydon Strut

## Description

**H-132-OS x 10' PG**

**Deep 1-5/8" Slotted Pre Galv**

**H-164-OS x 10' PG**

**Shallow 13/16" Slotted Pre Galv**

**TR 1/4" x 10 EG**

**1/4" Threaded Rod 10'**

**TR 3/8" x 10 EG**

**3/8" Threaded Rod 10'**

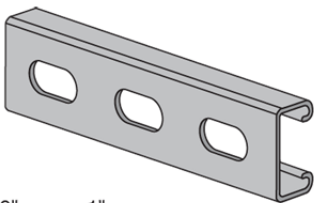

9" x 1 1/8" Dia. Holes

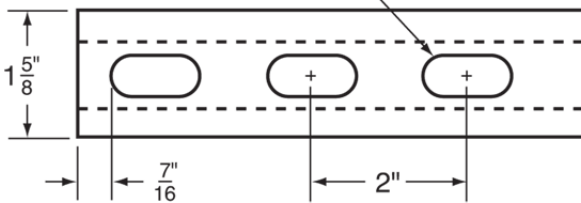

**USA MADE  
100% Domestically  
Manufactured**

- Pre-Galvanized Steel
- Plain Steel
- Aluminum
- Stainless Steel
- Hot Dipped Galvanized
- Zinc
- Powder Coated Supr-Green
- PVC Coating 40ML

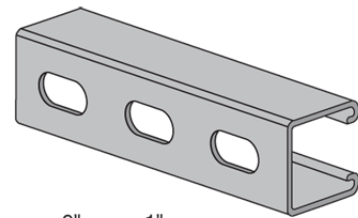

9" x 1 1/8" Dia. Holes

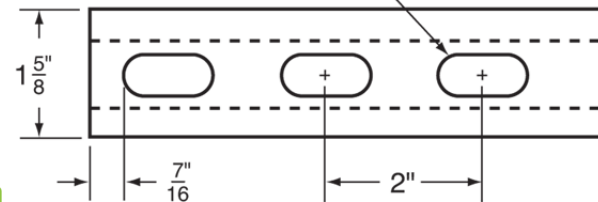

National Electrical Manufacturers  
Representatives Association



Local 210 International  
Brotherhood of Teamsters  
All products are Union made.

# Learn More about Haydon by Scanning the Code

## Back to Back

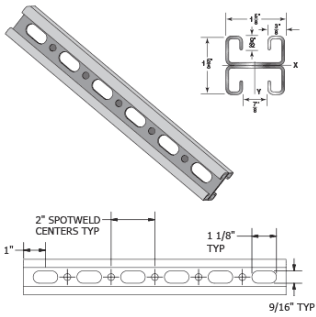

## Base Plates

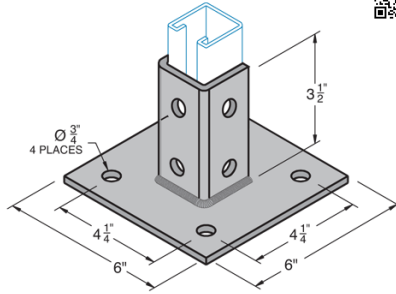

## Beam Clamps

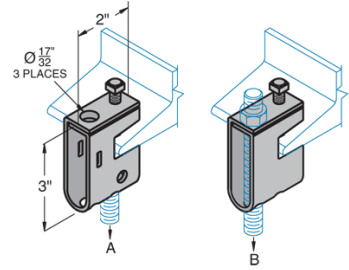

## Back to Back

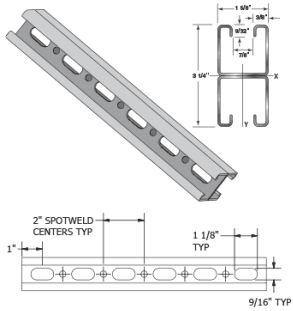

## Clamps

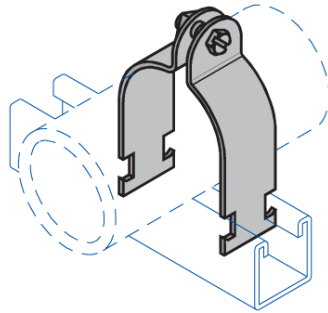

## Grip Nuts

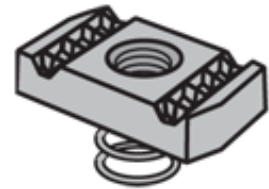

## Threaded Rod

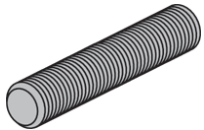

### All-Thread Rod

Diameter	Thd.	Wt./100 Ft.
1/4"	20	12
3/8"	16	30
1/2"	13	54
5/8"	11	85
3/4"	10	125

FINISH: Electro-Galvanized/Plain  
LENGTH: 6', 10' & 12'

## Clamps

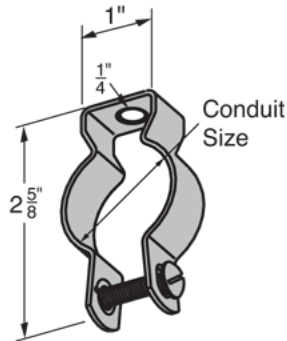

## Channel Brackets

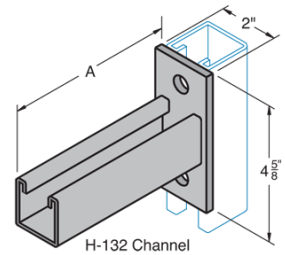

## Solid Strut

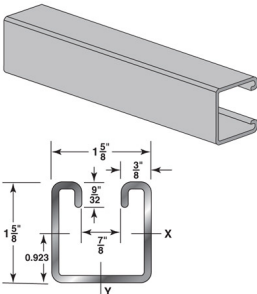

## General Fittings

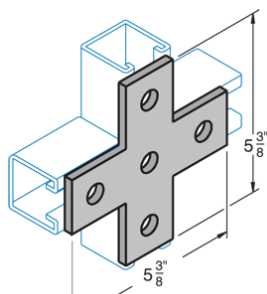

## Closure Strip

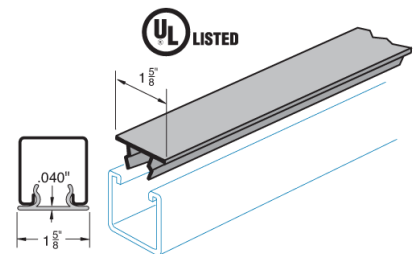

**Robert Neumann**  
BSR | Rainier Marketing  
Sales

robert@rainiermarketing.com  
O: 253.987.5775  
C: 253.335.0425

**Carrie Crane**  
BSR | Rainier Marketing  
Sales

carrie@rainiermarketing.com  
O: 253.987.5775  
C: 253.987.5775

**Greg Todd**  
BSR | Rainier Marketing  
Sales

greg@rainiermarketing.com  
O: 253.987.5775  
C: 206.619.0341

We are available to meet with you and review your next project.

www.blueskyreps.com